

**NATIONAL NEWS**

**RL24 - It's YOUR kind of boat**

PRESIDENT.	Bruce Castles (051) 442639
SECRETARY.	Ken Hackett (051) 444346
TREASURER	Craig Rainey (051) 444382
NEWSLETTER	Ken Hackett.

*Word*
  
*051/443988*

17th NATIONAL TITLES SET FOR NOOSA.

Queensland will host the 1990 National Championship regatta at Lake Cootharaba, near the resort town of Noosa, from 29th December 1989 to 7th January 1990. Notice of Race will be out soon.

State secretary, Genny Garrad (Dump Truck) writes "camping is available at Boreen Point Camping Ground, (071) 853244, - no electricity, plenty of room, on the waters edge, yachts can be moored in front of camp site. Also adjacent to the yacht club at Everglades Caravan Park (071) 853213 - electricity, units, some on-site vans, reservations required. Boreen Pt. is situated approx. 15 to 20 minutes from Tewantin and Noosa. The road is dirt but well used. If more suitable Tewantin and Noosa can be used for accommodation. More details in Notice of Race."

Genny also sends us this account of their state titles in which they had a different winner in each heat:-

QUEENSLAND STATE TITLES were held at Lake Coothara over Easter. 18 boats participated and racing was tight and competative from the front of the fleet to the back of the fleet for every race. The Queensland Association has been running these titles under a handicap basis. The reason for this is to see the swing keelers racing on a competative level with the drop keelers. Lengthy discussion was given to this handicap at the recent A.G.M. and it was decided to continue with this system until the handicap is adjusted so that a fair system is used to determine the winners. Of the 18 boats, 10 were swing keel RL24s and the performance from all boats was simply magnificant for both sailers and spectators. Overall the series was a total success and every boat went away happy and with a feeling of achievement.

I personally thank all the boats for participating and making my years work seem all worth while.

Finally the results :-

- FIRST      Aquilla/Tecumseh  
                  Aquilla sailed by Gearge Tarratt and Tecumseh sailed by Ron Collins. These boats tied for first on handicap and first swing keel RL24. Congratulations to both skippers and crew members.
- SECOND    Sea Mist sailed by Bob Elliot and crew
- THIRD     F-Troop sailed by Dave Parmenter and crew.

These results are based on the handicap system used by the Queensland RL24 Association.

Ed.- Sea Mist is a Mk.1 converted to a Drop Keel with a North Rig. F.Troop is a Mk.1V, lightweight. Both are from Gladstone.

## NATIONALS AT LAKE WELLINGTON

So we went to the titles at Lake Wellington Yacht Club. We knew our boat was slow but we participated as intended and had a great time sailing around the bouys in the swing-keel division.

Doug Laity in Streaker showed us all his bare transom in every race winning seven straight! Congratulations Doug and your crew; National and State Champion Swing-keel Division.

We had use of a caravan as did a number of others. They were provided by the club and very competitive with the going rate for that time of year and there was no charge for anything else! Those who used their own van or camped in tents had no camp fees at all! There were hot showers, clean toilets, 240 volt power and use of club kitchen. Also beer, wine, mixed drinks all chilled and available at very reasonable prices from very pleasant barmen and barladies. A daily run to Sale by club members made obtaining fresh bread, milk, ice, etc a simple matter. We wanted for nothing. The success of this series can be directly credited to the members of L.W.Y.C. and the RL24 committee. Helen Castles designed the motif for the screen printing of tee shirts and the printing was available on your shirt at 50 cents a time! Thankyou for your time ladies.... Barbara Castles, Ruth Hacket, Merle Rainey and others. Mal Griffith;

Following each race we joined a short happy hour and then to the indoor barbeque to rub shoulders with the famous and infamous crews from other boats. Every night we enjoyed the company of other families in the balmy night air or in the clubhouse where Jan Wood one night accompanied a blooming sing-a-long with her guitar. An out of control trivial pursuit took over on another. Then there was the snooker challenge saga between the female crews of Jacqui and Eumlebee, Sue and Lee versus Charlie and John, crew of F Troop from Queensland. The boys could do nothing at times to stop the onslaught.

Some fashions of the field saw Barry Aitkin of Lowana V in shorts with tadpoles on them.....said they were his seamen shorts. Bruce Castles wore a whopping blue and white number that went well with his wishbone rig. He was the envy of all the skippers.

The winds were strong for some races and light in others but in the main good sailing weather where some boats planed for a good portion of the gybe legs. The last race had Jack Lucas in Radical Lady 2 setting a record for the most crew in a titles race. Eight up!... Says he challenges anybody to stack on more at a future series. The gauntlet was also thrown down by Solace who ran 3rd in the swing-keel division. The skipper of any swing-keel boat who can finish ahead of her in the long distance race of the next series will be bought a round of drinks after the race.

Many fond memories of great sailing and companionship which is typical of the RL people was culminated in a wonderful night out at the Princeton Motor Lodge Sale for the presentation of trophies. A ladies night out you might say, where the atmosphere and meal were superb and the hilarious floorshows presented by the crews and families reflected the harmony that existed on and off the water.

We were sorry it was over.....till next time.

Dick & Jennifer Armstrong

PMM:

### VOYAGE INTO THE UNKNOWN...PAYNESVILLE OR BUST!

As the proud owner of the recently acquired "Street Car" I was greatly excited by the prospect of competing in the 21st Marlay Point Overnight Race.

While greatly boosting the coffers of Telecom I'd managed to recruit a crew of experienced, though somewhat geriatric, former Fireball stalwarts; Roger Byrne and Keith Chatto from Melbourne and Peter Rodda from Canberra. Ten year old daughter Elizabeth joined the crew to add that feminine touch.

To counter the pre-race nerves my trusty crew was put to work making "fine" adjustments to the boat, tapering new spinnaker sheets, replacing cleats etc., while the owner walked amongst the other entrants, passing the time of day, conducting the odd safety check and spying on all the latest "go fasts". While this fine tuning may have settled the crew's nerves, the ensuing thirst they developed may have counteracted the benefits.

The first drama of the day occurred on launching, when the trailer winch refused to let go. This was followed closely by the shear pin tossing in the towel on the trusty SUBLI. "It's never happened before" I assured my crew.

Despite these minor set backs and the subsequent running aground spreading the cheeks of the rudder box, we managed to make it to deeper water to conduct our first and final training run.

After this thorough preparation we managed a reasonably good start at the port end of the line. We made it across Lake Wellington in great shape, 2 hours 8 minutes later. We later discovered that the "Flying Doctor" in Lowana VI had streaked across in 1 hour 50 minutes, closely followed by Bruce Castles' Pegasus, 5 minutes astern.

In the next hour or so we discovered what this event is all about, and why people keep coming back year after year. Apart from the sailing, the entertainment was something else. The Sydney to Hobart may have it's New Year Party at Constitution Dock, but it surely can't compete with the Strait's floating discos, naked corroborees (Lie down and go back to sleep, Elizabeth!) and bacchanalian barbeques!

Overcome by all this activity, not the close quarter sailing, the Street Car contingent fell off the pace somewhat, and by the turn at Shaving Point off Metung, we were 1 hour 40 minutes behind the Lowana VI combination. They went on to finish a very creditable 3rd in Division 3, only 2 minutes behind the winner Craig Rainey, who deserted the ranks to compete in his newly launched Flying Fifteen.

The winners took only 11 hours 11 minutes in a race of which all but 1 hour 20 minutes was sailed on the wind. Congratulations Craig and Simon on a great performance.

Meanwhile, back on Street Car all was not lost as the trusty crew decided to lift the tone of the event. While Greg Hood on Pegasus piped his team across the finishing line to the strains of "Hull of kintyre", completely destroying the concentration of all close competitors, we sat down to our breakfast of beef stroganoff in formal attire. This only seemed to attract the attention of aggressive boats who proceeded to attack our hard earned position. We managed to fight most of them off, but alas, spilt our beer, spread stroganoff and noodles all over the cockpit, tangled the spinnaker and lost a bow tie over the side.

Needless to say we all had a great time and rest assured we'll all be back next year for a tilt at the 22nd Marlay Point Overnight Race.

(Ed. - Always knew the MPONR was a prestige event, but formal attire yet!!! For the record 13 RL24 SK's started and 11 DK's with a 1% handicap difference for the first time in this event. The flying doctor in Lowana VI got it all together and was the 1st RL in by a staggering 41 minutes to finish overall 8th on corrected time in the 120 strong division. Doug Laity made amends for his accident last year by sailing his MK1 Swing keeler, Streaker into 2nd spot in the RL fleet, ahead of several well performed drop keelers. The above account is from John Wood, former sheet trimmer on Pegasus).

## HULL CRADLE

A simple safe way to inspect your keel.

If you do not have the room to roll over your boat, try this easy single handed method.

A frame fabricated from steel or 4x3 hardwood as per Don Lewis design will allow access to the keel for inspection or complete removal from the hull.

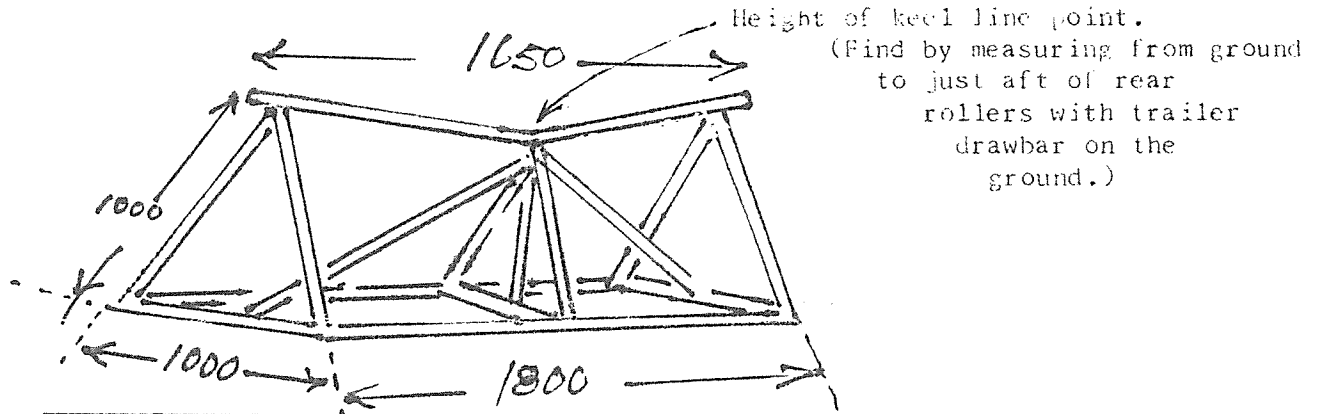

- 1/ Anchor the hull to your neighbour's tree.  
Pull trailer out from under the boat 12-18".

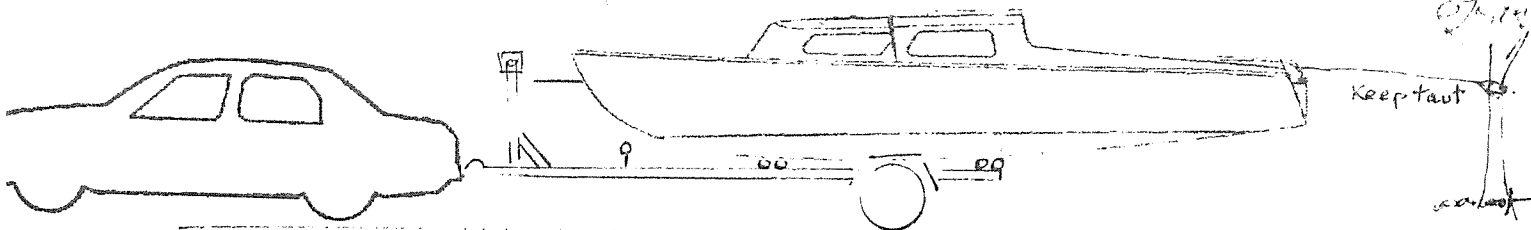

- 2/ Lower drawbar, and place cradle under hull where rear rollers normally support the hull.

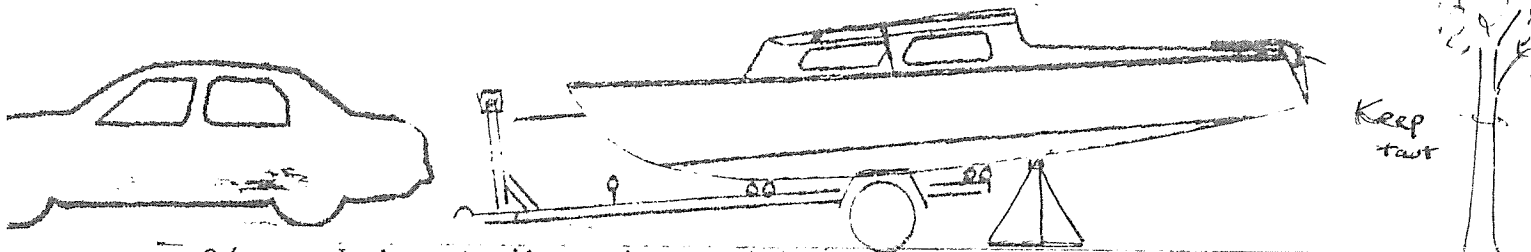

- 3/ Jack up trailer and connect to car.  
The hull should now be clear of the rear rollers and the weight transferred to the cradle.

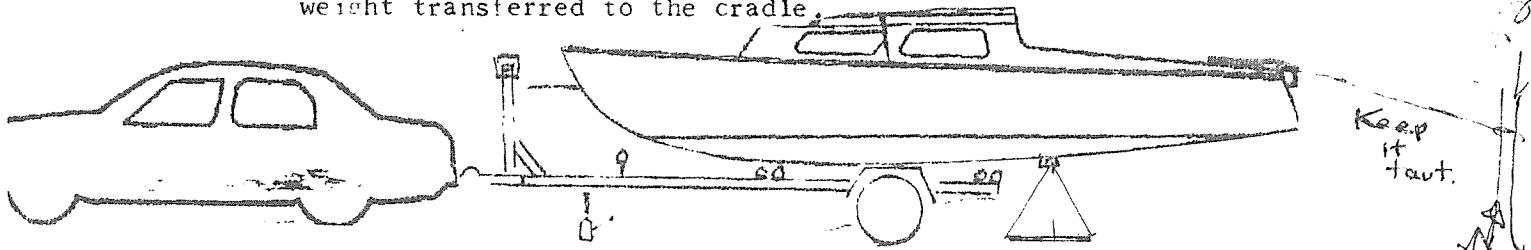

- 4/ Pull trailer out until the keel slot is clear of the trailer rear rollers.

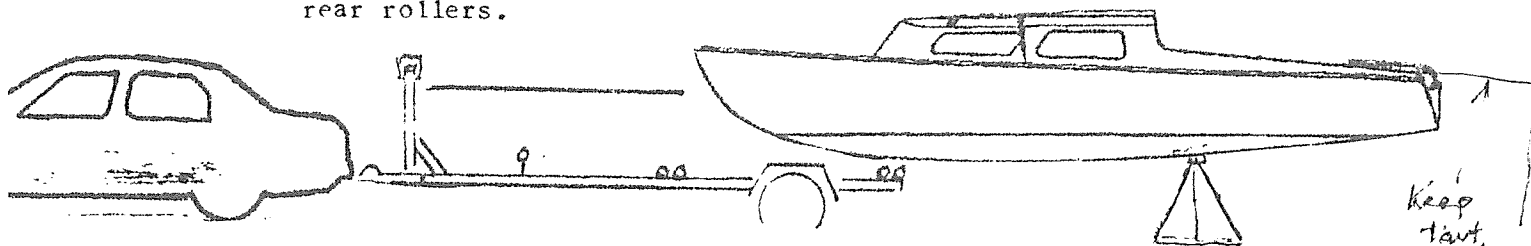

- 5/ Chock the trailer wheels.  
Fit two small stands under the rear of the trailer.  
Disconnect car and neighbour's tree.  
Keel may now be lowered to ground level.

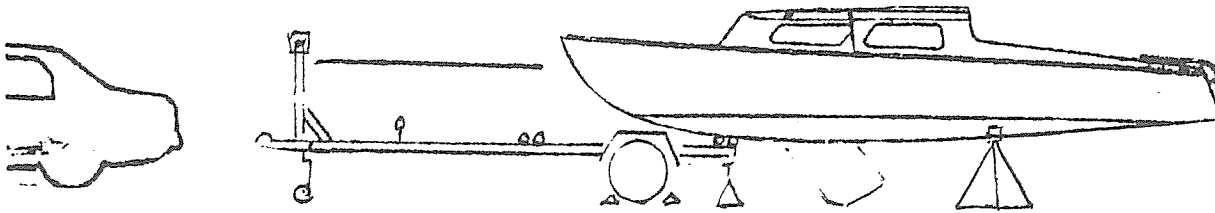

This results in a very safe stable support. A shallow hole may be dug to enable the keel to swing to the vertical. The keel may be removed using the keel winch combined with a car jack.

To fit her back on the trailer.

- 1/ Connect car to trailer. (Hull anchoring may be necessary.)
- 2/ Remove wheel chocks and trailer stands.
- 3/ With car out of gear and brakes off, winch the car and trailer under the hull.
- 4/ Lower drawbar to remove cradle.
- 5/ Complete winching to her home position.

LAUNCH ONTO THE GROUND FOR TRAILER MAINTENANCE

To replace old rollers how many of us have launched our boats onto the water and completed trailer repairs at the launching ramp car park?

Why not do the repairs at home?

All you need are the cushions from your lounge suite or some old tyres will do just as well to protect the hull. Also a solid object to anchor the hull while you pull the trailer out from underneath.

- 1/ Anchor hull to tree, clothes-line or chook-house and winch up tight.  
Place two tyres under her stern and one each side of the hull as per diagramme.  
This is all that is needed for her to sit down comfortably.  
You might like to put down some carpet or timber along the keel line if the ground is rough.

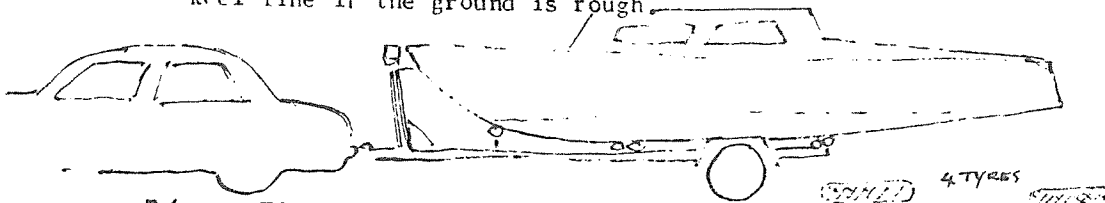

- 2/ Tilt the trailer, disconnect the winch cable.  
Drive forward slowly pulling the trailer out and she will sit down happily.

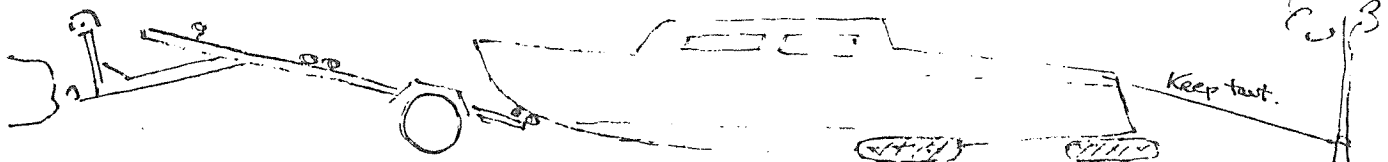

- 3/ To get her back on the trailer, leave her anchored and retrieve normally.  
With the car out of gear and brakes off, winch the trailer with car attached under the hull.  
She will come up easily and...

## NATIONAL RL CHAMP - STATE FF CHAMP.

Craig Rainey showed his form in the Lake Wellington Nationals was no fluke when he jumped back into his flying fifteen for the Victorian Championships. Teaming with regular forward hand, Simon Walsh, Craig took out the title from a very strong fleet on Lake Victoria. Now in a brand new hull the boys are getting set for the up-coming world championships on Moreton Bay in December.

## RL24 VICTORIAN CHAMPIONSHIPS 1990.

Rhyll Yacht Club will host the next Vic. Title on Westernport Bay. This series will be a departure from other titles in that only four races will be scheduled over the 3 day Australia Day weekend in January.

## RHYLL WEEKEND.

An institution has evolved in Victorian RL circles known as the Rhyll Weekend. This is a regular date in February each year when RL families get together for a weekend of fun on Phillip Island. Of course there is a yacht race on the program and this year 13 RL's turned out to contest Olney's Gong. This "fun" race is usually, of course, quite fierce. This year was no exception with the last 500 meters to the finish resembling an America's Cup tacking duel. Lowana VI took advantage of local knowledge to suck Sasha into covering over the shallows until Sasha hit bottom while Lowana sewerman, Jenny, quietly wound up enough keel to clear. While all this was going on Wings almost stole the race by sailing her own course at the other end of the long finish line. All to no avail in the end as The Gong went to swing keeler "Streaker". Well done Doug Laity. Thanks once again to the Shannon family and their most generous hospitality - a truly memorable weekend.

## VICTORIAN TRAILER SAILER CHAMPIONSHIPS.

This series of eight races held at different venues around the State through the season is conducted by the Victorian Yachting Council to determine the champion trailer sailer. The elite fast division attracted some hot competition but we are pleased to report that RL24's still dominate. First place for the series went to Lowana V helmed by Barry Aitken. Second place to Pegasus sailed by Bruce Castles. Congratulations to the crews of both yachts - you did our class proud. On a sadder note though, we have to report that Lowana V has now been sold. It seems we have lost from RL ranks the very popular and competitive (former National Champion) Barry Aitken. Barry still shares an Etchels so presumably will continue in that class.

## VYC YACHTING SUMMIT.

This month sees the yachting authority in Victoria making the first significant step to reverse the slow decline in yachting in this state. Representatives from all Victorian Yacht Clubs and Associations have been invited to a live-in weekend to analyse/discuss/debate and listen to guest speakers. Zim is to come up with a plan to lift our collective game. Good to see this concerted effort. Lets hope it gathers momentum.

## SOUTH AUSTRALIAN NEWS.

News is there isn't any. We spoke to the current SA President who reports great difficulty in co-ordinating the widely scattered RL population in that State. Accordingly he declined as impractical the invitation to take up the SA Associations turn to host National Titles. Pity. We do have a few readers in South Australia - perhaps they would like to make individual contact with the editor to let us all know where they are sailing, what sailing success/problems they have, etc.

## BOAT SHOW.

The Boating Industry Association and the Victorian Yachting Council have patched up their differences and are co-operating again for the 1989 Boat Show in Melbourne's Exhibition Building. Coming up in July and yes there will be a RL24 Association stand. Lloyd and Sue Graham did such a top job last time they won the guernsey again. But please be a willing helper. Details of what help is needed later.